

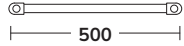







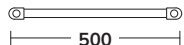

STRAIGHT Towel Rails

MATERIAL	Steel
FIXING	Fix to wall brackets supplied.
STANDARDS	EN442-1, DOP-SON-006/19

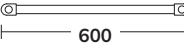
	Height (mm)	Width (mm)	Finish/Colour	Pipe Centre (mm)	BTU	Code
	1800		Chrome	460	2259	STW185SCP
		—	—	—	—	—
		—	—	—	—	—
	1200		Chrome	560	2570	STW186SCP
		—	—	—	—	—
		—	—	—	—	—
	800		Chrome	460	1436	STW125SCP
		—	—	460	2154	STW125SAT
		—	—	460	2154	STW125SBLK
	1200		Chrome	560	1633	STW126SCP
		—	—	560	2451	STW126SAT
		—	—	560	2451	STW126SBLK
	800		Chrome	460	1027	STW085SCP
		—	—	460	1540	STW085SAT
		—	—	460	1540	STW085SBLK
	1200		Chrome	560	1168	STW086SCP
		—	—	560	1572	STW086SAT
		—	—	560	1572	STW086SBLK

800mm Towel Rails

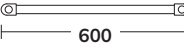
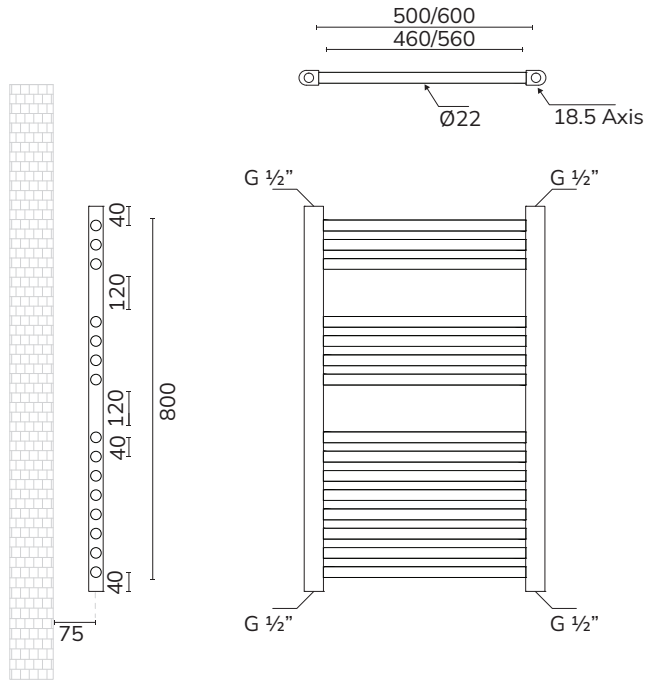

1200mm Towel Rails

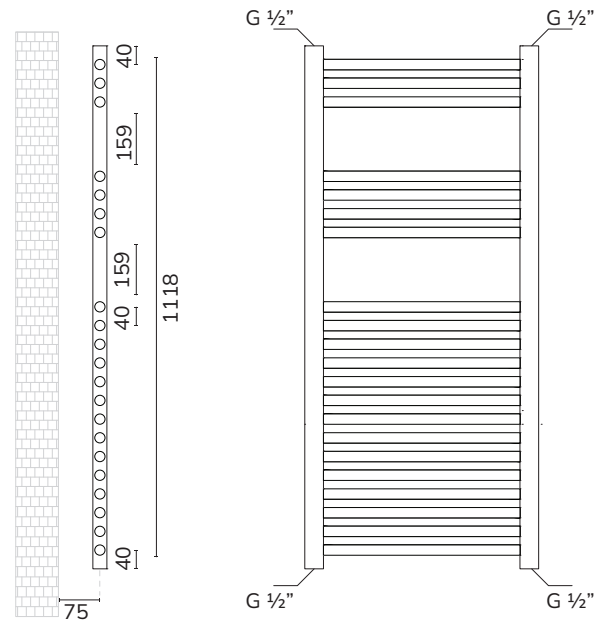

1800mm Towel Rails

